

FAGERHULT

SE - 566 80 Habo

Vialume 75 G2

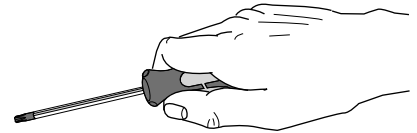

(S) Armaturen bör placeras så att långvarigt tittande direkt in i armaturen inte förväntas på ett avstånd närmre än 1 m.

(GB) The luminaire should be positioned so that prolonged staring into the luminaire at a distance closer than 1 m is not expected.

1.

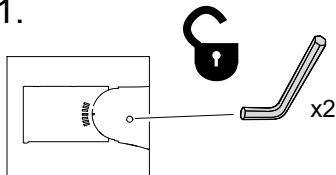

3.

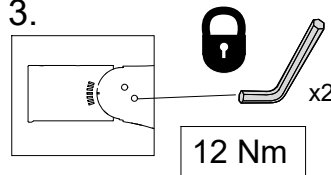

2.

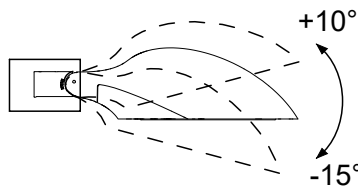
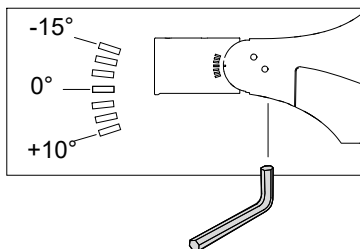

MAX 8 M

Max weight 6kg

Max projected area
From below 0,0989m²
From the side 0,0424m²

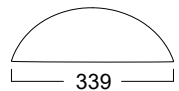

InnerØ 41±1

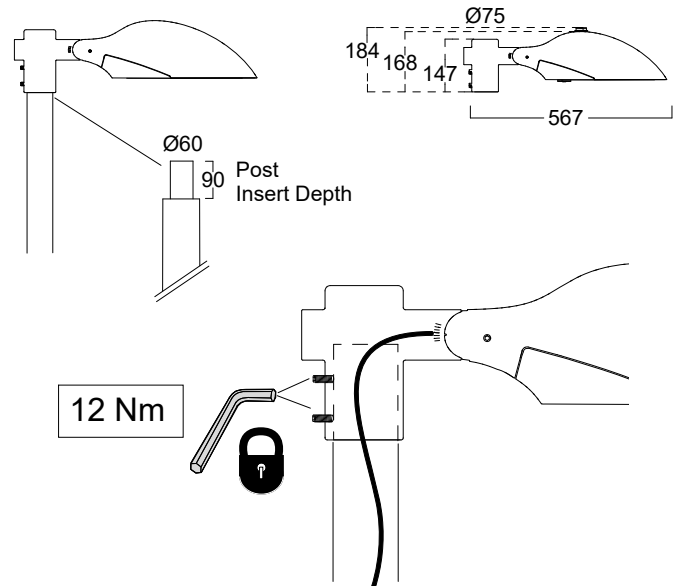
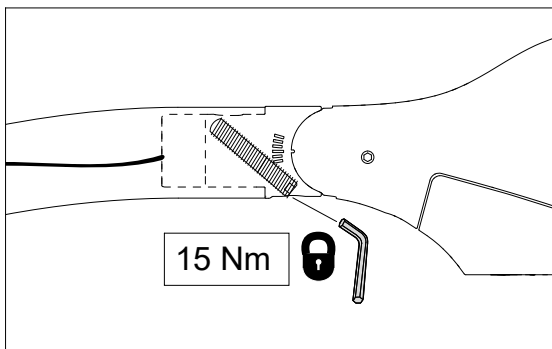
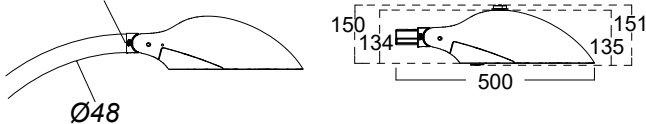

5461073 Utgåva/Edition 01

●	DA-	(S) Grundläggande isolering mellan nät och styr ledning.
●	DA+	
⊕	⊕	(GB) Basic insulation between mains and control wiring.
⊖	N	
⌋	L	

(S) Ljuskälla och drivdon ska enbart bytas ut av tillverkaren eller dess utsedd person.

(GB) The light source and control gear shall only be replaced by the manufacturer or its designated person.

Class II

(S) Om armaturens kabel skulle skadas skall den bytas av tillverkaren, eller av tillverkaren utsedd person.

(GB) If the cord of this luminaire is damaged, it shall exclusively be replaced by the manufacturer, or by the manufacturer designated person.

(S) Det är lämpligt att denna information överlämnas till användaren av anläggningen.

(GB) It is appropriate that this information is passed on to the users of the installation.

Manufactured by Fagerhult Sweden.
For UK market importer Fagerhult UK
33-34 Dolben Street, London, SE1 OUG